



# Installations- und Konfigurationsanleitung — KEBA KeContact P30 x-series

Version:2023.3.1

## Table of Contents

<b>1. Introduction</b>	<b>2</b>
1.1. Legal provisions	2
1.2. Qualification of the installing electrician	2
1.3. Symbols used	2
1.4. Darstellungskonventionen	2
<b>2. Produktbeschreibung</b>	<b>2</b>
2.1. Scope of delivery	2
2.2. Prerequisites	3
<b>3. Commissioning</b>	<b>4</b>
3.1. Ethernet connection	4
3.2. Configuration of the DIP switches	6
3.2.1. Setting the charging station control functions	7
3.2.2. Setting the permissible amperage	8
3.2.3. Further DIP switches	9
3.2.4. Charging network	10
3.3. § 14a of the German Energy Industry Act (EnWG)	11
<b>4. Install Symphon-E App KEBA KeContact P30 x-series</b>	<b>15</b>
4.1. Direct Installation	15
4.1.1. Redeem already registered license key	18
4.1.2. Redeeming a new license key	19
4.2. Edit EMS app	21
<b>5. Contact</b>	<b>22</b>
<b>6. Verzeichnisse</b>	<b>23</b>
6.1. Abbildungsverzeichnis	23

## 1. Introduction

### 1.1. Legal provisions

The information contained in these documents is the property of Heckert Solar GmbH. Publication, in whole or in part, requires the written consent of Heckert Solar GmbH.

Subject to changes and printing errors!

### 1.2. Qualification of the installing electrician

A qualified electrician is a person who has the necessary experience and training:

- Setting up, switching on, switching off, disconnecting, short-circuiting and repairing circuits and devices
- Standard maintenance and use of protective devices in accordance with current safety standards
- First aid/emergency care
- Current knowledge of local regulations, standards and guidelines

### 1.3. Symbols used

Before reading the manual, you should familiarize yourself with the different types of safety warnings. You should also familiarize yourself with the importance of the safety warnings.

### 1.4. Darstellungskonventionen





	This symbol indicates an imminent danger. If this danger is not avoided, it can lead to death or serious injury.
	This symbol indicates a potentially dangerous situation. If this dangerous situation is not avoided, it may result in minor or moderate injury.
	This symbol indicates a warning. Failure to observe this warning may result in damage and/or destruction of the system.
	This symbol indicates a note. It is recommended that the note be observed.

Table 1. Darstellungskonventionen

## 2. Produktbeschreibung

### 2.1. Scope of delivery

Prüfen Sie, nachdem Sie die Lieferung erhalten haben, ob alle Bestandteile mitgeliefert wurden. Prüfen Sie den Lieferumfang auf Beschädigungen. Sollte etwas fehlen oder beschädigt sein, wenden Sie sich bitte sofort an den Lieferanten. Folgende Komponenten sind in der Lieferung enthalten:

- KEBA KeContact P30 x-series Ladestation

- 11 kW bzw. 22 kW mit integriertem 4-Meter-Anschlusskabel und Typ-2-Stecker oder
- 22 kW mit Typ-2-Steckdose, zum Anschließen eines eigenen Kabels
- Installationsanleitung — Typ-2-Ladestation KEBA 11/22 kW 4 m/Steckdose

## 2.2. Prerequisites

Für den Einsatz der Ladestation ist erforderlich:

- Symphon-E App KEBA KeContact P30 x-series



Die »Symphon-E App KEBA KeContact P30 x-series« ist nicht im Lieferumfang enthalten. Diese muss — falls noch nicht vorhanden — zusätzlich erworben werden.

### 3. Commissioning

## 3. Commissioning



To install the KEBA charging station, please follow the instructions in the "KeContact KC-P30 Charging Station Installation Manual".  
[Installation manual — KEBA KeContact KC-P30](#)



The "Configuration Manual" for the x-series should also be read and internalized:  
[Configuration manual — KEBA KeContact P30 x-series](#)



This quick guide refers to the original user manuals. It serves as an installation aid for qualified electricians in the area of communication interfaces, but is not a substitute for studying the user manuals.

### 3.1. Ethernet connection

The network connection is made via the LSA terminal block X4.



Please note that the Ethernet connection X3 (here: RJ45) was designed as a service port. This is not suitable for a permanent, stable connection to the Heckert Solar Energy Management System.

To connect to the LSA terminal block X4, the network cable must be disconnected and the cables need to be connected to pins 1-4.

The assignment type of the customer network must be observed.

Pin	-568A Paar	-568B Paar	-568A Farbe	-568B Farbe
1 (Tx+)	3	2	weiß / grüner Strich	weiß / oranger Strich
2 (Tx-)	3	2	grün / weißer Strich oder grün	orange / weißer Strich oder orange
3 (Rx+)	2	3	weiß / oranger Strich	weiß / grüner Strich
4 (Rx-)	2	3	orange / weißer Strich oder orange	grün / weißer Strich oder grün

Figure 1. Diagram for the network connection

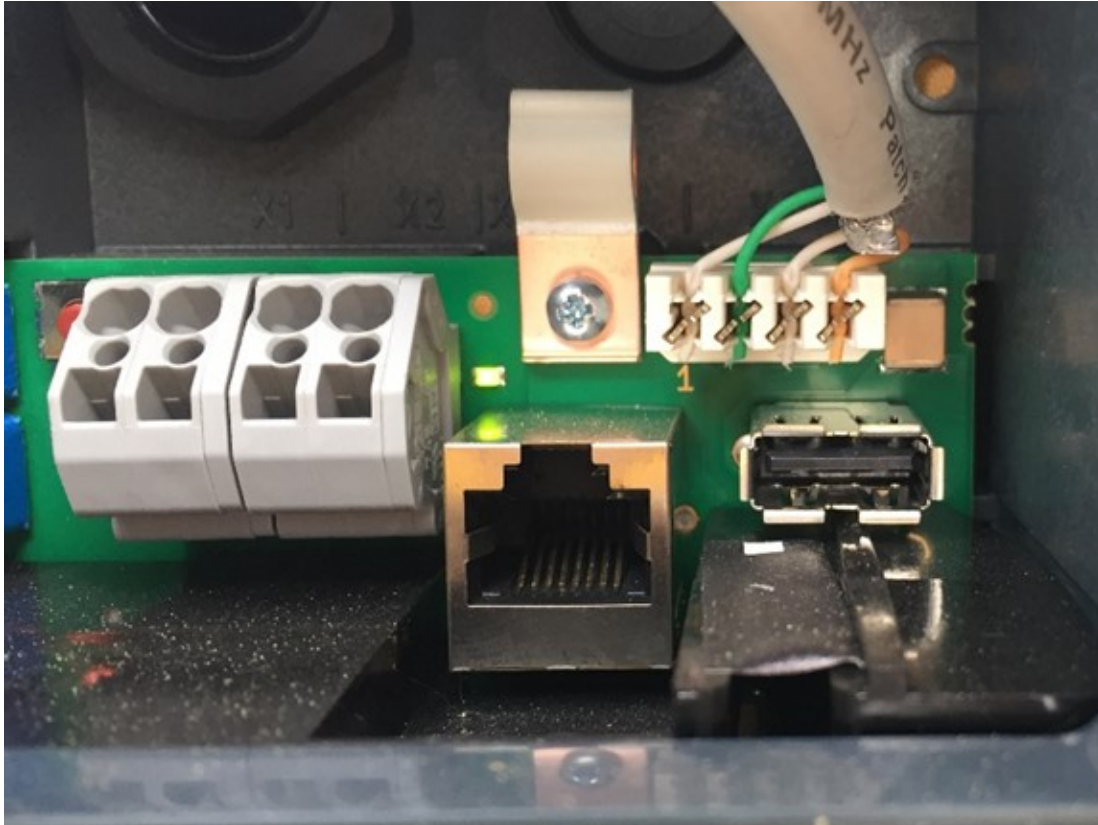

Figure 2. Example of the network connection

After connection to the customer network, the wallbox is assigned an IP address using DHCP. This IP address can be determined in the DHCP server, e. g. the router, or can be read on the display when the wallbox is started.

DIP-Switch	Funktion	Abbildung
DSW2.1 DSW2.2 DSW2.3 DSW2.4	Nicht gültig für P30 x-series. Standardmäßig wird der Ladevorgang selbstständig ohne übergeordnetes Steuerungssystem von der Ladestation durchgeführt. Die Ladestation versucht bei Bedarf eine IP-Adresse über einen DHCP-Server zu erhalten. Dies entspricht auch der Grundeinstellung für Ladestationen ohne Netzwerkverbindung.	

Figure 3. Setting the lower switch panel for DHCP



An IP address can only be assigned via DHCP if the DIP switches of the second switch panel D2.1 to D2.4 are set to "OFF".

To be able to access the wallbox via its IP address for testing purposes, your computer must be in the same network. Open an internet browser and enter the IP address identified.

Example: <http://123.123.123.123>

After entering your login data (included in the scope of delivery), a website opens that looks like this:

### 3.2. Configuration of the DIP switches

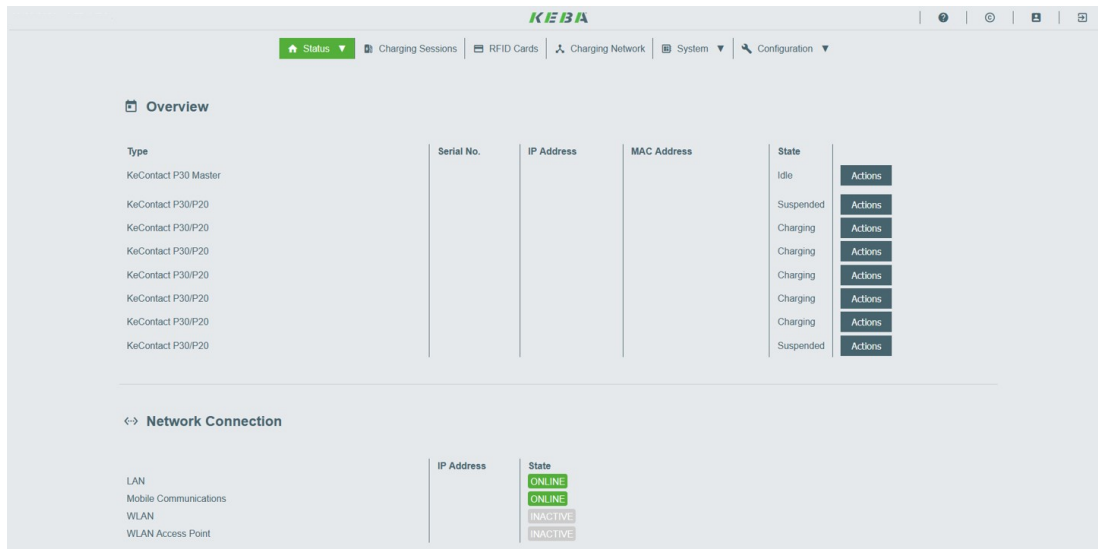

Figure 4. KEBA software

The Keba x-series web interface offers numerous settings. Among other things, RFID card authorizations can be managed and an automatic charging report, which is used to bill the charging sessions, can be created. Further information is found in the configuration manual for the KEBA x-series: [Configuration manual — KEBA x-series](#)

### 3.2. Configuration of the DIP switches

Various settings such as IP assignment and control can be made via the DIP switches. In the following illustration you can see the two positions of the switches.

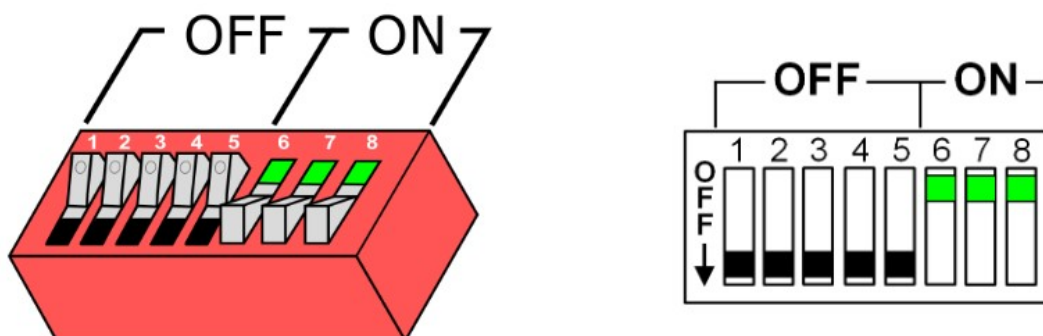

Figure 5. DIP switch

The DIP switches can be accessed by removing the front cover. Here you will find two different switch panels, which are explained in more detail below.

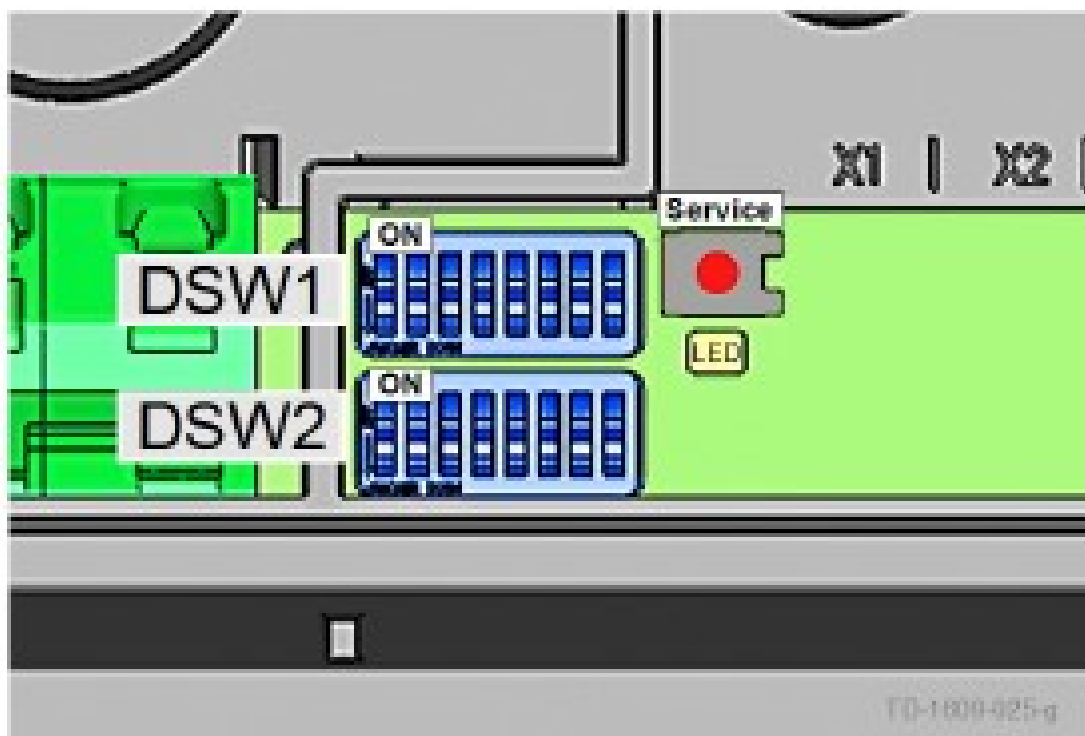

Figure 6. DIP switch DSW

We differentiate here between the top panel "DSW1" and the bottom panel "DSW2".

### 3.2.1. Setting the charging station control functions

The first three DIP switches on the upper DSW1 panel are used to control and forward signals from the charging station.

Of these three switches we only need D1.3, which is used to activate the SmartHome interface via UDP, allowing the EMS to set the charging specifications for the charging station via the UDP protocol. D1.1 and D1.2 remain in the "OFF" position.



### 3.2. Configuration of the DIP switches

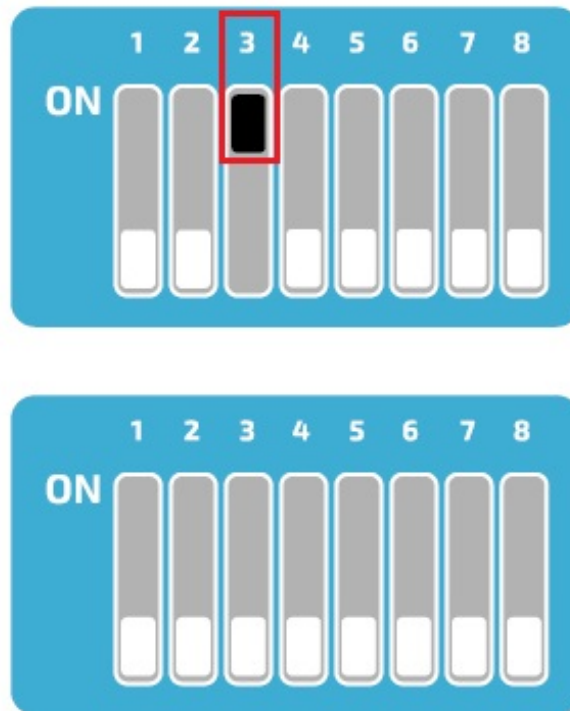

Figure 7. Setting the upper switch bar for UDP

#### 3.2.2. Setting the permissible amperage

DIP switches D1.6 - D1.8 are used to set the permissible current, which determines the maximum charging power of the charging station, provided the vehicle to be charged supports this charging power.

DIP-Switch	Stromstärke	Abbildung
DSW1.6 DSW1.7 DSW1.8	8 A Einstellung verfügbar ab Software $\geq 1.18.00$ / Firmware $\geq 3.10.56$ (Details siehe „10.3 Software/ Firmware-Version anzeigen“)	
DSW1.6 DSW1.7 DSW1.8	10 A	
DSW1.6 DSW1.7 DSW1.8	13 A	
DSW1.6 DSW1.7 DSW1.8	16 A	
DSW1.6 DSW1.7 DSW1.8	20 A	
DSW1.6 DSW1.7 DSW1.8	25 A	
DSW1.6 DSW1.7 DSW1.8	32 A	

Figure 8. Setting the amperage

### 3.2.3. Further DIP switches

However, all other DIP switches have no function in conjunction with the EMS or can influence the connection, e. g. D2.8.

They therefore remain in the "OFF" switch position after commissioning.

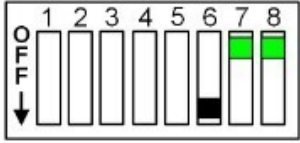
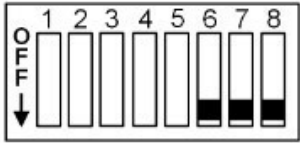
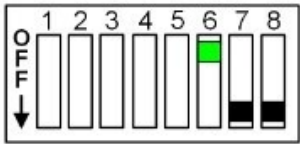
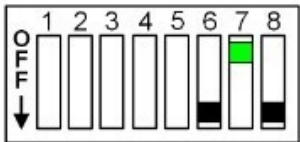
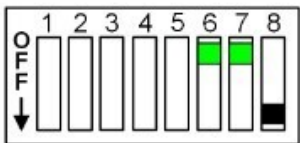
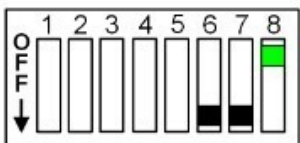
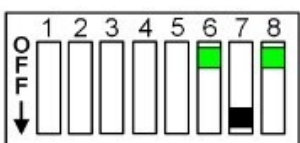
### 3.2. Configuration of the DIP switches

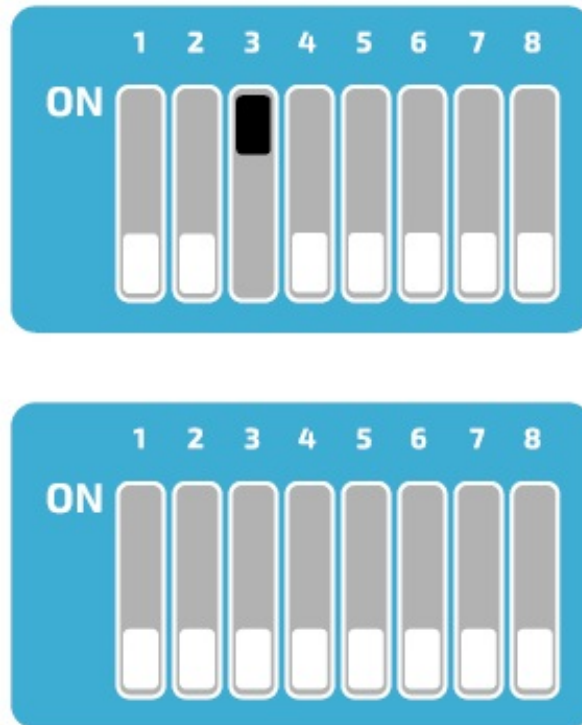

Figure 9. Setting the DIP switches for a wallbox

#### 3.2.4. Charging network

The Keba KeContact P30 **c-series** can be used as a slave in a charging network with a Keba KeContact P30 **x-series**. In this case, the **x-series** takes over the management of the RFID authorization. To enable communication between the charging stations, the DIP switch D2.5 must be activated on all charging stations (**x-series and c-series**). In addition, the **c-series** must have received a dynamic IP address from the DHCP server. If there is no charging network (only one charging station is available), the DIP switch D2.5 does not need to be activated.

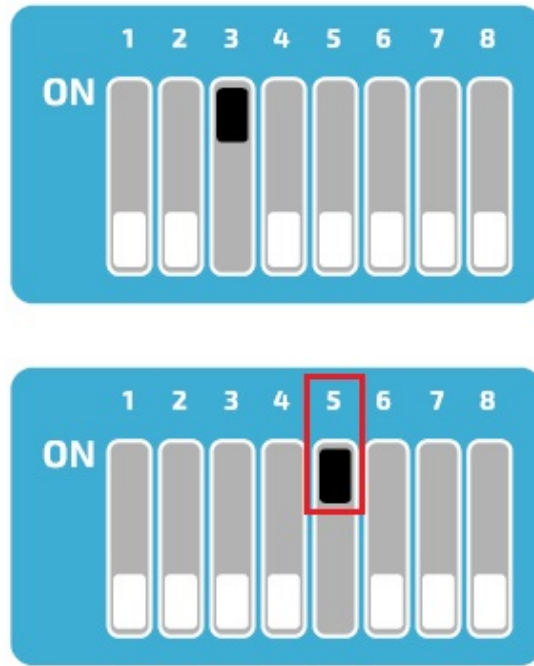

Figure 10. Setting the DIP switches for a charging network

### 3.3. § 14a of the German Energy Industry Act (EnWG)

From 01/01/2024, all wallboxes & charging stations in the private sector must be controllable by the grid operator in accordance with § 14a of the German Energy Industry Act. Depending on the manufacturer, your wallbox can be dimmed to the required 4.2 kW charging power and/or switched off for the required period of time.



Currently, the proper dimming of wallboxes & charging stations is not achieved via the Heckert Solar energy management, but via solutions provided by the wallbox manufacturers.

#### Prerequisites

All §-14a-compliant KEBA KeContact Series that can be integrated into the EMS Online Monitoring are listed below.

Wallbox model type	§-14a conformity (e. g. potential-free contact X1, Modbus TCP, OCPP)
KEBA KeContact P30 X-Series	✓
KEBA KeContact P30 C-Series	✓
KEBA KeContact company car wallbox	✓
KEBA KeContact PV Edition	✓

Table 2. 14a-compliant KEBA KeContact Series models



A KEBA KeContact can currently be properly integrated into the Energiemanagement System via the potential-free contact X1.

#### Connection of the control box

### 3.3. § 14a of the German Energy Industry Act (EnWG)

The device is configured via the potential-free contact X1 of the compatible KeContact charging station.

Connect the control box to the input and output terminals of the potential-free contact X1 as shown in the [Circuit diagram for the potential-free contact X1](#).

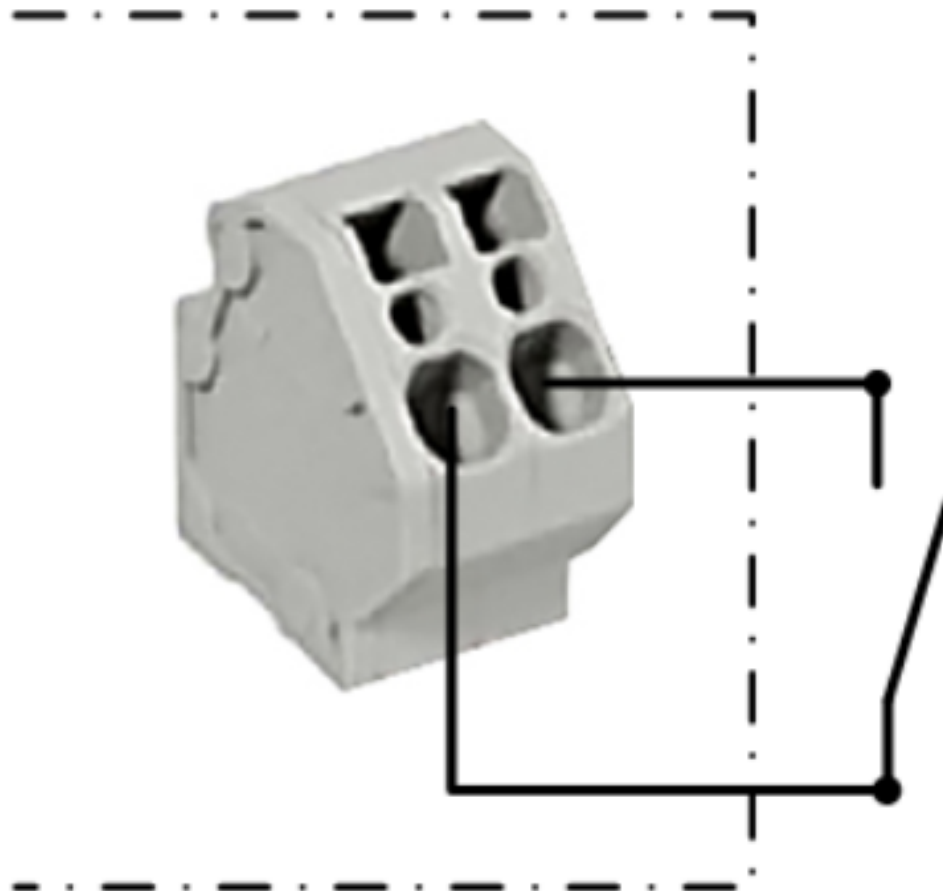

Figure 11. Circuit diagram for the potential-free contact X1

To enable control by external components (here: control box), the DIP switch D1.1 must be set to "ON".

The wallbox then needs to be restarted.

DIP-Switch	Funktion	Abbildung
<b>DSW1.1</b>	<p>Verwenden des externen Freigabe-Eingangs X1 zum Starten eines Ladevorgangs.</p> <p>DSW1.1 ON: Ladefreigabe bei geschlossenem X1. Die Ladefreigabe ist zusätzlich abhängig von der RFID-Autorisierung. Details siehe <a href="#">7.4 Freigabe-Eingang X1</a>.</p> <p>DSW1.1 OFF: Bei nicht verdrahtetem Freigabe-Eingang X1.</p> <p>Bei allen Gerätevarianten für Großbritannien/ United Kingdom darf die Werkseinstellung nicht verändert werden, da andernfalls die Manipulationserkennung nicht mehr korrekt funktioniert.</p>	

Figure 12. DIP switches for contact X1

### Setting up the EnWG-compliant amperage

From software version 1.18 or firmware version 3.10.56, the available charging current for the KeContact P30 series can be set to 0 A or 6 A in accordance with EnWG using the DIP switches.

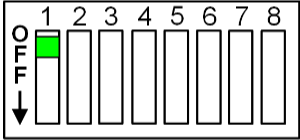

In software version 1.17.2, the EnWG-compliant current was predefined to 8 A. For further information, please refer to the KEBA KeContact manuals or visit [KEBA KeContact FAQ](#).

To reduce the charging current to a specific value, set DIP switch D2.6 to the desired position.

DIP-Switch	Funktion	Abbildung
<b>DSW2.6</b>	<p>Nicht gültig für P30 e-series.</p> <p>Beim Öffnen oder Schließen des Freigabekontakts X1 wird der verfügbare Ladestrom auf einen bestimmten Wert reduziert.</p> <p>Der Freigabe-Eingang X1 muss aktiviert sein (<b>DSW1.1 = ON</b>).</p> <p><b>DSW2.6 = OFF = Wert: 0A</b>  <b>DSW2.6 = ON = Wert: 6A</b> (gültig ab Software <math>\geq 1.18.00</math> / Firmware <math>\geq 3.10.56</math>, ältere Versionen verwenden <b>8A</b>)</p>	 <p>Beispiel: Strombegrenzung ein</p>

Figure 13. Charging current via DIP switch D2.6



Activating DIP switch D1.1 results in new dependencies for starting a charging process using RFID authorization.

RFID	DSW 1.1	Beschreibung
Aus	OFF	Permanente Ladefreigabe – das Laden ist immer möglich.
Aus	ON	Ladefreigabe bei geschlossenem X1.
Ein	OFF	<p><b>P30 a-series b-series und c-series (ohne Ladenetzwerk)</b></p> <p>Ladefreigabe bei geschlossenem X1 <b>ODER</b> korrekter RFID-Autorisierung. Der Zustand von X1 wird während des Ladevorgangs nicht mehr geprüft. Der Ladevorgang kann nur mittels RFID-Karte vorzeitig beendet werden.</p> <p><i>Wenn keine RFID-Karte eingelernt wurde, ist das Laden immer möglich, sowohl bei offenem als auch bei geschlossenem X1.</i></p>
Ein	ON	<p><b>P30 a-series b-series und c-series (ohne Ladenetzwerk)</b></p> <p>Ladefreigabe bei geschlossenem X1 <b>UND</b> korrekter RFID-Autorisierung.</p> <p><i>Wenn keine RFID-Karte eingelernt wurde, erfolgt die Ladefreigabe bei geschlossenem X1.</i></p>
Ein	OFF	<p><b>P30 c-series (in einem Ladenetzwerk) und x-series</b></p> <p>Ladefreigabe bei korrekter RFID-Autorisierung.</p> <p><i>Ohne RFID-Karte ist kein Laden möglich.</i></p>
Ein	ON	<p><b>P30 c-series (in einem Ladenetzwerk) und x-series</b></p> <p>Ladefreigabe bei geschlossenem X1 <b>UND</b> korrekter RFID-Autorisierung.</p> <p><i>Ohne RFID-Karte ist kein Laden möglich.</i></p>

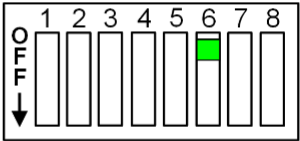
Figure 14. Requirements for initiating a charging process

Die Konfiguration ist hiermit abgeschlossen.

## 4. Install Symphon-E App KEBA KeContact P30 x-series

In the Symphon-E App Center you will find all installable Symphon-E Apps — such as the Symphon-E App KEBA KeContact P30 x-series.



In the user manual [Symphon-E App Center](#) you will find detailed instructions on how to use the Symphon-E App Center. It also describes how to register and redeem a license key.

There are two ways to install an app via the Symphon-E App Center. Only the [\[Direct installation\]](#) is described below, whereby a license key is registered and redeemed in the EMS.

### 4.1. Direct Installation

To install the Symphon-E App KEBA KeContact P30 x-series directly, go to the overview of the Symphon-E App Center.



Only apps from the "Available" category can be installed.

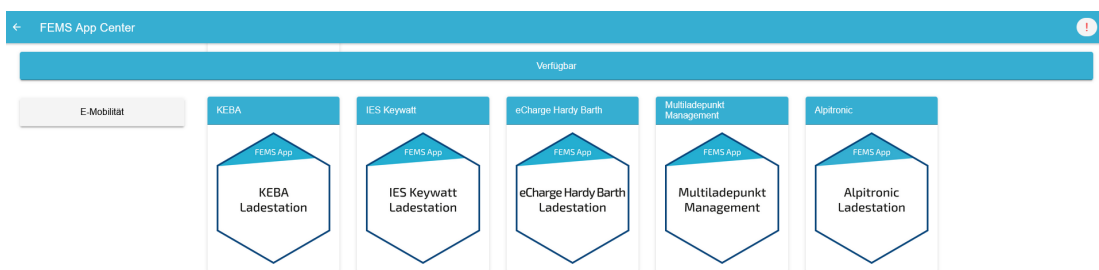

Figure 15. App installation — Variant 2: Step 1

Select the Symphon-E App KEBA KeContact P30 x-series by clicking on it.

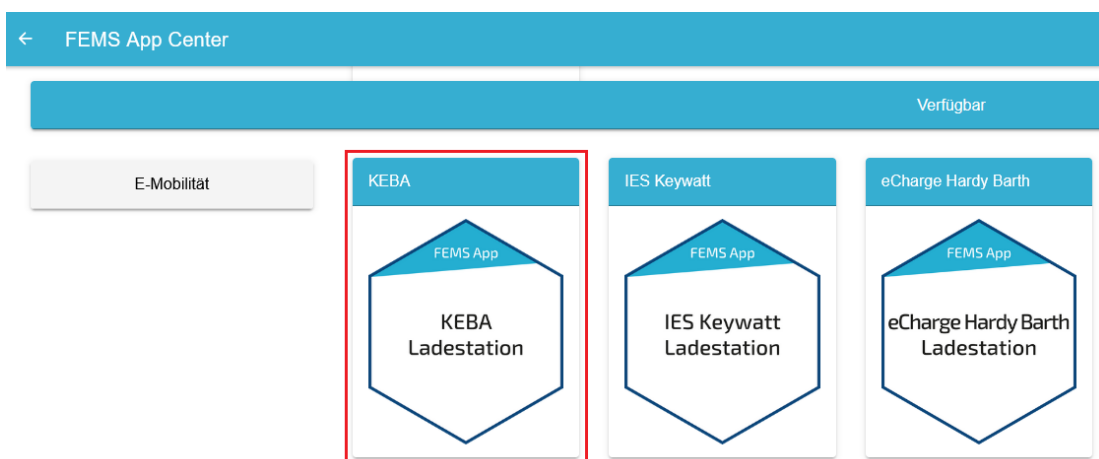

Figure 16. App installation — Variant 2: Step 2

You will then be taken to the app overview.



## 4.1. Direct Installation

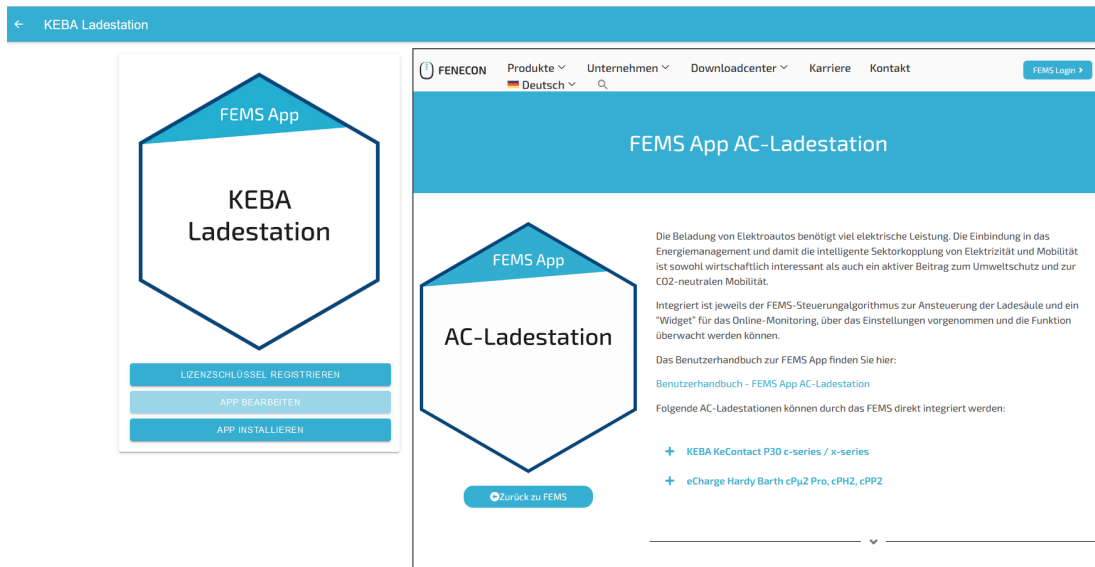

Figure 17. App installation — Variant 2: Step 3

Click on the "Install app" button.



Figure 18. App installation — Variant 2: Step 4

An input mask for redeeming a license key appears.

Lizenzschlüssel einlösen
×

Geben Sie hier den Lizenzschlüssel ein, den Sie mit der Bestellung der App erhalten haben

Bereits registrierten Lizenzschlüssel einlösen?

---

Registrierte Lizenzschlüssel\* XXXX-XXXX-XXXX-XXXX ▼

---

Lizenzschlüssel\* XXXX-XXXX-XXXX-XXXX

---

ABBRECHEN

LIZENZSCHLÜSSEL EINLÖSEN

Figure 19. App installation — Variant 2: Step 5

You have two options here.

#### 4.1.1. Redeem already registered license key

If you want to redeem an already registered license key, select it (1). Then click on the button of the same name to redeem the selected license key (2).

Lizenzschlüssel einlösen
×

Geben Sie hier den Lizenzschlüssel ein, den Sie mit der Bestellung der App erhalten haben

Bereits registrierten Lizenzschlüssel einlösen?

---

Registrierte Lizenzschlüssel\* XXXX-XXXX-XXXX-XXXX ▼

---

Lizenzschlüssel\* XXXX-XXXX-XXXX-XXXX

---

ABBRECHEN

LIZENZSCHLÜSSEL EINLÖSEN

1 →

2 ↑

Figure 20. App installation — Variant 2: Step 5a

### 4.1.2. Redeeming a new license key

If you have not yet registered a license key or wish to redeem a new license key, enter the 16-digit key in the corresponding field (1) and then click on "Validate license key" (2). The entered license key is then checked for validity.

**Lizenzschlüssel einlösen** ✕

Geben Sie hier den Lizenzschlüssel ein, den Sie mit der Bestellung der App erhalten haben

Bereits registrierten Lizenzschlüssel einlösen?

Registrierte Lizenzschlüssel\* XXXX-XXXX-XXXX-XXXX ▼

Lizenzschlüssel\* XXXX-XXXX-XXXX-XXXX 1 →

LIZENZSCHLÜSSEL VALIDIEREN 2

Figure 21. App installation — Variant 2: Step 5b

If the license key is valid, it can be redeemed by clicking on the button of the same name. If the license key is recognized as invalid, please check your entry and try again.

Lizenzschlüssel einlösen
✕

Geben Sie hier den Lizenzschlüssel ein, den Sie mit der Bestellung der App erhalten haben

Bereits registrierten Lizenzschlüssel einlösen?

---

Registrierte Lizenzschlüssel\* XXXX-XXXX-XXXX-XXXX ▾

---

Lizenzschlüssel\* XXXX-XXXX-XXXX-XXXX

---

ABBRECHEN

LIZENZSCHLÜSSEL EINLÖSEN



Figure 22. Redeeming a new license key: Step 6

You will then be taken to the installation wizard for Symphon-E App KEBA KeContact P30 x-series.

KEBA Ladestation

Alias*	KEBA Ladestation
IP-Adresse*	192.168.25.11
Phasenrotation <small>Verkabelung der einzelnen Phasen der Ladestation zu den Phasen im Netz</small>	L1_L2_L3 ▾

APP INSTALLIEREN

Figure 23. App installation — Variant 2: Step 7

Some of the input fields are pre-filled. Nevertheless, enter your data if it differs from the default values (e. g. IP address). Otherwise, the default values can be retained (e. g. port, Modbus unit ID).



Mandatory fields are marked with \*



Check your entries and make sure that they are correct. Otherwise the respective app will not work properly!

Then click on "Install app".

KEBA Ladestation	
Alias*	KEBA Ladestation
IP-Adresse*	192.168.25.11
Phasenrotation <small>Verkabelung der einzelnen Phasen der Ladestation zu den Phasen im Netz</small>	L1_L2_L3 ▾
<input type="button" value="APP INSTALLIEREN"/>	

Figure 24. App installation — Variant 2: Step 8

Once the installation process is complete, the new app appears in the overview of the Symphon-E App Center in the "Installed" category.

## 4.2. Edit EMS app



Apps that have already been installed can be subsequently edited to change configuration settings. To do this, select the respective app in the Symphon-E App Center overview and click on the "Edit app" button. Detailed instructions are found in the user manual [Symphon-E App Center](#).

Die Symphon-E App KEBA KeContact P30 x-series wurde erfolgreich installiert.

## 5. Contact

For support, please contact:

Symphon-E Service

Telephone service: +49 (0) 371 45 85 68 - 100

E-mail service: [symphon-e@heckert-solar.com](mailto:symphon-e@heckert-solar.com)

## 6. Verzeichnisse

### 6.1. Abbildungsverzeichnis

- [Figure 1. Diagram for the network connection](#)
- [Figure 2. Example of the network connection](#)
- [Figure 3. Setting the lower switch panel for DHCP](#)
- [Figure 4. KEBA software](#)
- [Figure 5. DIP switch](#)
- [Figure 6. DIP switch DSW](#)
- [Figure 7. Setting the upper switch bar for UDP](#)
- [Figure 8. Setting the amperage](#)
- [Figure 9. Setting the DIP switches for a wallbox](#)
- [Figure 10. Setting the DIP switches for a charging network](#)
- [Figure 11. Circuit diagram for the potential-free contact X1](#)
- [Figure 12. DIP switches for contact X1](#)
- [Figure 13. Charging current via DIP switch D2.6](#)
- [Figure 14. Requirements for initiating a charging process](#)
- [Figure 15. App installation — Variant 2: Step 1](#)
- [Figure 16. App installation — Variant 2: Step 2](#)
- [Figure 17. App installation — Variant 2: Step 3](#)
- [Figure 18. App installation — Variant 2: Step 4](#)
- [Figure 19. App installation — Variant 2: Step 5](#)
- [Figure 20. App installation — Variant 2: Step 5a](#)
- [Figure 21. App installation — Variant 2: Step 5b](#)
- [Figure 22. Redeeming a new license key: Step 6](#)
- [Figure 23. App installation — Variant 2: Step 7](#)
- [Figure 24. App installation — Variant 2: Step 8](#)